

1310nm 20mW DFB Laser Diodes | TO18 5.6mm LD | Flat Window Optional
1310nm 20mW Single Mode LD | With Non-spherical Lens | Built-in Photodiode

WSLD-1310-020m-1-PD

Wavespectrum Laser Group

www.wavespectrum-laser.com

1310nm Laser Diode 20mw		Wavespectrum Laser Group	
Reverse Voltage	V_r	2.0	V
Operating Temperature	T_{op}	-20 ~ +50	°C
Storage Temperature	T_{stg}	-40 ~ +85	°C
Lead soldering temperature (10 sec.)	T_{is}	260	°C
Features: <ul style="list-style-type: none"> ● 1310nm ● Built-in PD ● DFB ● Single Mode Beam ● TO18 Package 			
Applications: <ul style="list-style-type: none"> ● Optical Fiber Communication ● Free-space Optical Communication 			
Specifications	WSLD-1310-020m-1-PD		
Center Wavelength@25°C	1310+/-5nm		
Spectral Width (FWHM)	0.3nm		
Output Power	20mW		
Recommend Operating Temperature	25°C		
Laser Type	DFB		
Reverse current (PD) I_{rp}	2mA		
Reverse voltage (PD) V_{rp}	20V		
Beam Divergence (FWHM)	20°± x 9° //		
Threshold Current (Typ.)	10mA		
Operating Current (Typ.)	70mA		
Operating Voltage	1.3V		
Package Style	TO18		
Window Type	Flat Window (Optional)		
	Non-Spherical-Lens Window (standard)		



Package View

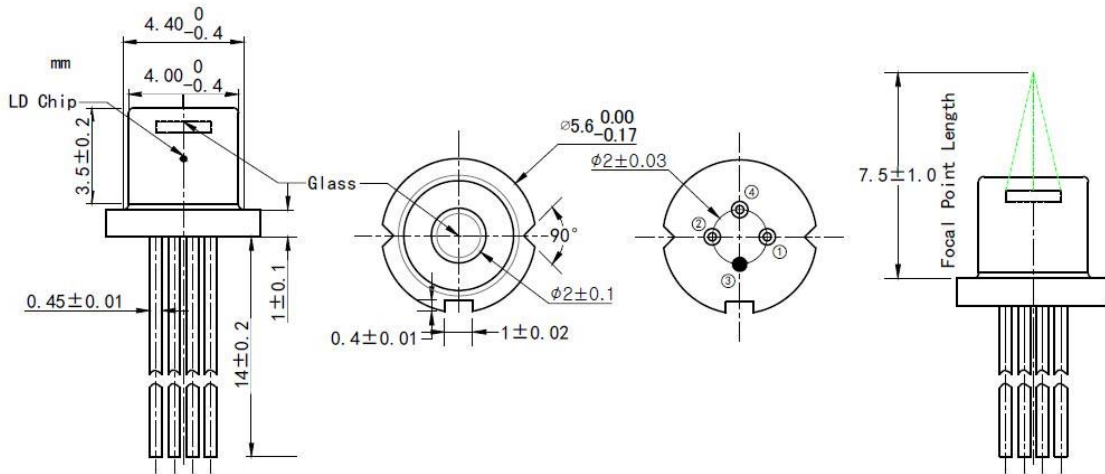

PIN Bottom View:

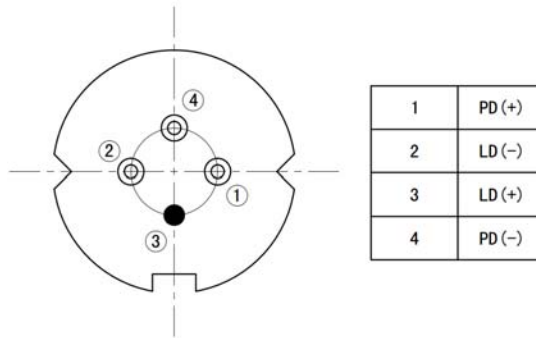

Electrically shorten LD module and store in non-extreme conditions.
Suggest using the constant current power supply.

